

KUGGREMSHJUL H

Kuggremshjul H med delning 12,7 mm

0014H075

Kuggremshjul H 75

- Standard är förborrade eller taper-lock
- Kan även fås kundanpassade
- Kuggremshjul H kan bearbetas



Produktbeskrivning

Kuggremshjul för H remmar

TEKNISK DATA

De	55,22 mm
Df	64 mm
Dm	40 mm
Dp	56,59 mm
F	26,4 mm
Figur	6F
L	40 mm
Profil	H
Tandantal z	14 st
Vikt	0,58 kg

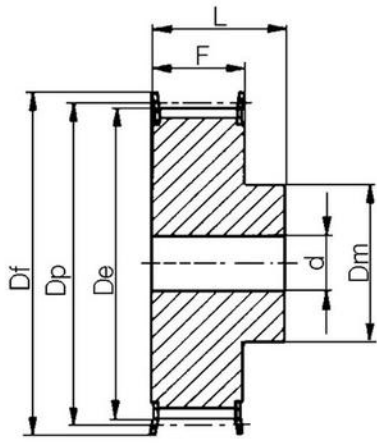

6F

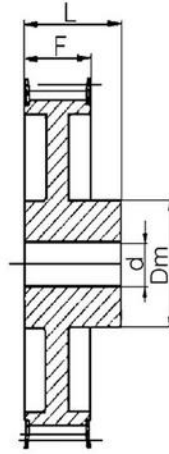

6WF

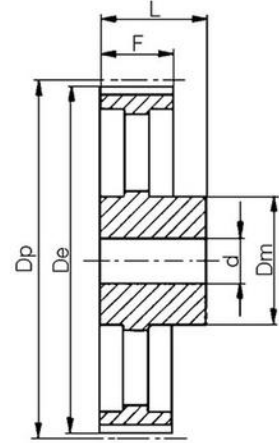

6A

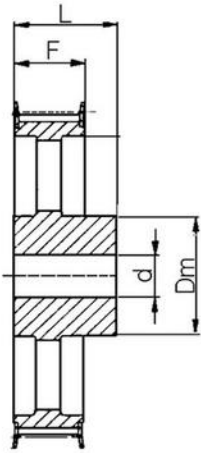

6AF

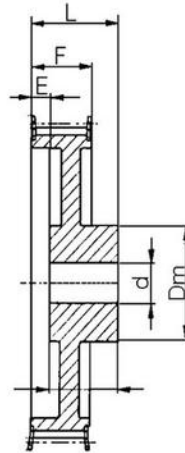

6CWF

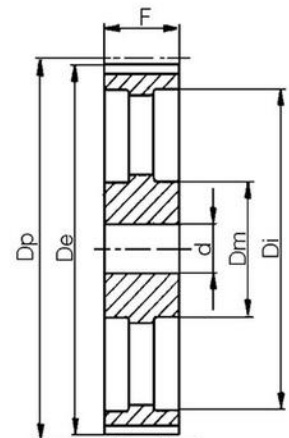

10A

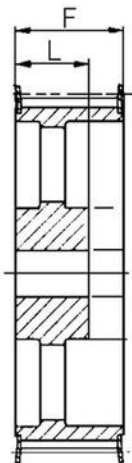

11AF

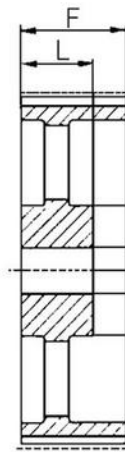

11A